

R/A COAX PLUG+HOUSING

R197.120.C01

CABLE 5/50

Series : SMB
CARLOCK

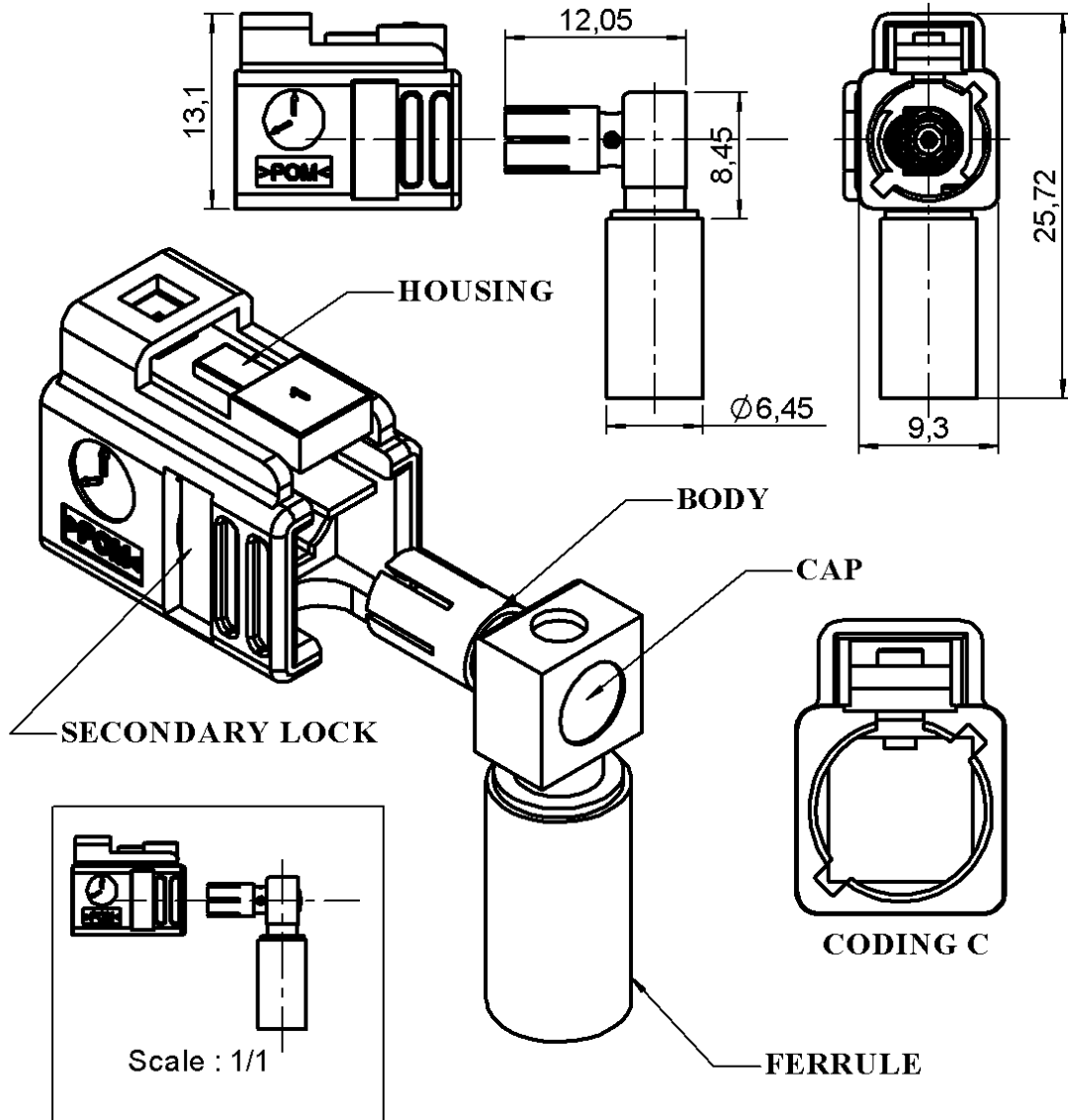

All dimensions are in mm.



COMPONENTS	MATERIALS	PLATINGS (µm)	
BODY CENTER CONTACT OUTER CONTACT INSULATOR GASKET OTHERS PARTS	BRASS BRONZE BRONZE PTFE - BRONZE	NICKEL . GOLD OVER NICKEL NICKEL	
HOUSING Secondary Lock	Polyoxyméthylène (POM) Polyoxyméthylène (POM)	NICKEL . UL CLASSIFICATION	COLOR
		UL 94V-2 UL 94V-2	BLUE RAL 5005 PURPLE RAL4003
		<i>*According with FAKRA specifications</i>	

Issue : 0043 A

In the effort to improve our products, we reserve the right to make changes judged to be necessary.



R/A COAX PLUG+HOUSING

R197.120.C01

CABLE 5/50

Series : **SMB**
CARLOCK

PACKAGING

Standard	Unit	Other
100	'W' option	Contact us

SPECIFICATION

ELECTRICAL CHARACTERISTICS

Impedance	50	Ω
Frequency range	0-2	GHz
	Frequency	1GHz 2GHz
	VSWR	1.05 1.100
Insertion loss	0.25	$\sqrt{F(\text{GHz})}$ dB Maxi
RF leakage	- (- F(GHz)) dB mini
Voltage rating	335	Veff Maxi
Dielectric withstanding voltage	1000	Veff mini
Insulation resistance	1000	M Ω mini

CABLE ASSEMBLY

Stripping	a	b	c	d	e	f
mm	5.00	8.00	15.0	10.0	0.00	0.00

Assembly instruction : page 4

Recommended cable(s)
RG 58

Cable retention
- pull off **180** N mini
- torque N.cm

MECHANICAL CHARACTERISTICS

Center contact retention	
Axial force – Mating end	10 N mini
Axial force – Opposite end	10 N mini
Torque	N.cm mini

Recommended torque	
Mating	N.cm
Panel nut	N.cm
Clamp nut	N.cm
A/F clamp nut	0.000 mm

Mating life	100 Cycles mini
Weight	3.784 g

TOOLING

Part Number	Description	Hexagon
R282.223.000	CRIMPING TOOL	5.41
R282.235.011	CRIMPING DIES	M22520/5-11
R282.293.000	CRIMPING TOOL	M22520/5-01

OTHERS CHARACTERISTICS

Housing locking strength 80N mini

ENVIRONMENTAL

Operating temperature	-40/+110 °C
Hermetic seal	NA Atm.cm3/s
Panel leakage	NA

Issue : **0043 A**

In the effort to improve our products, we reserve the right to make changes judged to be necessary.



R/A COAX PLUG+HOUSING

R197.120.C01

CABLE 5/50

Series : SMB
CARLOCK

VSWR

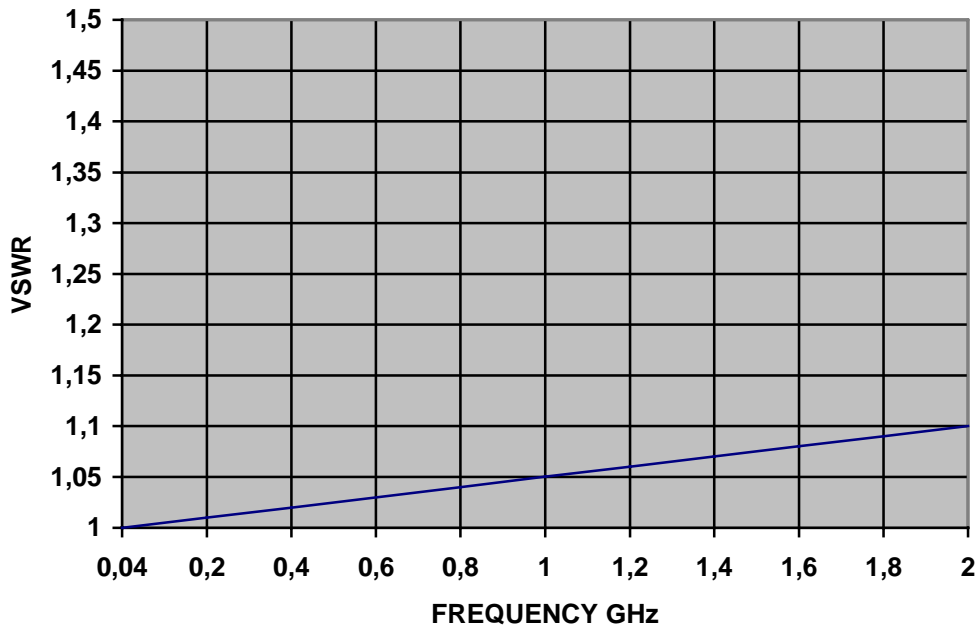

Issue : 0043 A

In the effort to improve our products, we reserve the right to make changes judged to be necessary.





R/A COAX PLUG+HOUSING

R197.120.C01

CABLE 5/50

Series : SMB
CARLOCK

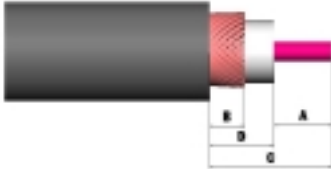
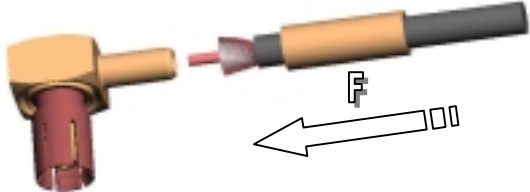
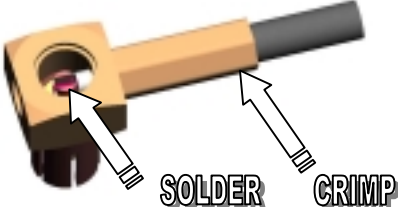
RECOMMENDED MOUNTING PROCEDURE

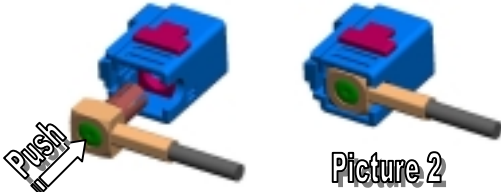
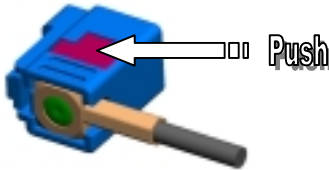
<p>1</p> <ul style="list-style-type: none"> • Slide onto the cable the ferrule • Strip the cable 	
<p>2</p> <ul style="list-style-type: none"> • Fan the braid • Push connector body under the braid • Slide the ferrule on the braid (in direction F) 	
<p>3</p> <ul style="list-style-type: none"> • Crimp the ferrule with crimping tool R282.223.000 (Hex:5.41) or crimping tool R282.293.000 (M22520/5-01) + dies R282.235.011 (M22520/5-11) • Solder inner conductor 	
<p>4</p> <ul style="list-style-type: none"> • Place the cap • Press cap flush or slightly below surface of body assembly 	
<p>5</p> <ul style="list-style-type: none"> • Push the coax in the housing till it snap on (according to picture 2) 	
<p>6</p> <ul style="list-style-type: none"> • To secure the coax inside the housing , push the secondary lock in final position (until it click on) 	

Issue : 0043 A

In the effort to improve our products, we reserve the right to make changes judged to be necessary.

